

2MP WDR (Motorized)VF Vandal-resistant Network IR Fixed Dome Camera

IPC3232ER3-DVZ28-C



Key Features

Optics

- Day/night functionality
- SmartIR, up to 30m (98 ft) IR distance
- Up to 120 dB OpticalWDR(Wide Dynamic Range)
- Lowlight surveillance
- 2D/3D DNR (Digital Noise Reduction)
- Built-in motorized lens for remote zoom

Compression

- Ultra 265,H.265, H.264, MJPEG
- Embedded smart algorithm
- Triple streams
- ROI (Region of Interest)
- 9:16 corridor mode

Network

- ONVIF Conformance

Structure

- Support PoE power supply
- Built-in PoE splitter that outputs DC 12V
- Wide temperature range: -40°C to 60°C (-40°F to 140°F)
- Wide voltage range of ±25%
- IK10 vandal resistant
- IP67

Specifications

IPC3232ER3-DVZ28-C	
Camera	
Sensor	1/2.9", progressive scan ,2.0 megapixel, CMOS
Lens	2.8~12mm, AF automatic focusing and motorized zoom lens
Angle of View (H)	94.0° (wide) ~28.0° (tele)
Shutter	Auto/Manual, 1/6~1/100000 s
Minimum Illumination	Colour: 0.01 Lux (F1.4, AGC ON) 0Lux with IR
Day/Night	IR-cut filter with auto switch (ICR)
Digital noise reduction	2D/3D DNR
S/N	>52dB
IR Range	Up to 30m (98 ft) IR range
Defog	Digital Defog
WDR	120dB
Video	
Video Compression	Ultra 265,H.265, H.264, MJPEG
H.264 code profile	Baseline profile, Main Profile, High Profile
Frame Rate	Main Stream:2MP (1920×1080): Max. 30 fps; Sub Stream:2MP (1920×1080): Max. 30 fps; Third Stream:D1 (720×576): Max. 30 fps
HLC	Supported
BLC	Supported
9:16 Corridor Mode	Supported
OSD	Up to 8 OSDs
Privacy Mask	Up to 8 areas
ROI	Up to 8 areas
Motion Detection	Up to 4 areas
Smart	
Behavior Detection	Intrusion, cross line, motion detection
Exception Detection	Audio detection

Intelligent Identification	Face detection, Defocus, Scene Change
Statistical Analysis	People counting
General Function	Watermark, IP Address Filtering, Tampering Alarm, Alarm input, Alarm output, Access Policy, ARP Protection, RTSP Authentication, User Authentication
Audio	
Audio Compression	G.711
Two-way audio	Supported
Suppression	Supported
Sampling Rate	8 KHZ
Storage	
Edge Storage	Micro SD, up to 128GB
Network Storage	ANR
Network	
Protocols	IPv4, IGMP, ICMP, ARP, TCP, UDP, DHCP, PPPoE, RTP, RTSP, RTCP, DNS, DDNS, NTP, FTP, UPnP, HTTP, HTTPS, SMTP, 802.1x, SNMP
Compatible Integration	ONVIF(Profile S, Profile G), API
Interface	
Audio I/O	Audio cable
	Input: impedance 35 k Ω ; amplitude 2 V [p-p]
	Output: impedance 600 Ω ; amplitude 2 V [p-p]
Alarm I/O	1/ 1
Network	1 RJ45 10M/100M Base-TX Ethernet
Video Output	1 BNC, impedance 75 Ω ; amplitude 1 V [p-p]
General	
Power	DC12V \pm 25%, PoE (IEEE802.3 af)
	Power consumption: Max.7.2 W
Dimensions (\varnothing x H)	\varnothing 148 x 111.3 mm (\varnothing 5.8" x 4.4")
Weight	0.75 kg (1.7 lb)
Working Environment	-40°C ~ +60°C (-40°F ~ 140°F), Humidity :10%~90% RH(non-condensing)
Ingress Protection	IP67
Vandal Resistant	IK10
Reset Button	Supported

Dimensions

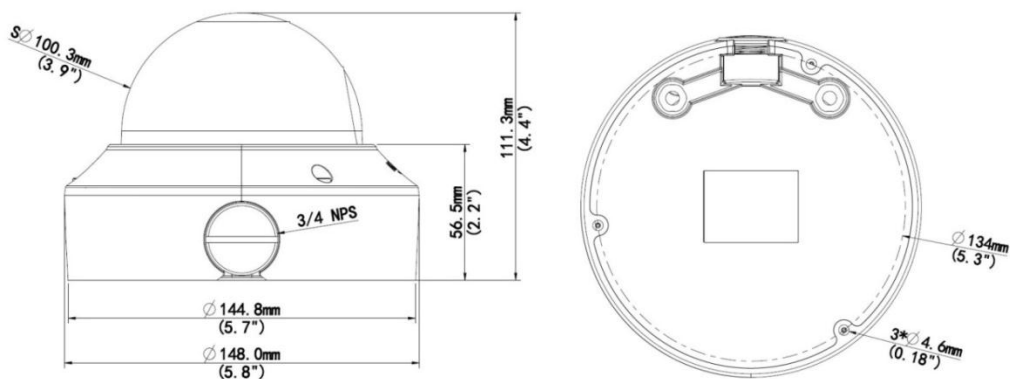

Accessories

Installation mode	Accessories	Description
Ceiling mount	Mounting pedestal is included in the product package	For indoor ceiling installation

Zhejiang Uniview Technologies Co., Ltd.

Building No.10, Wanlun Science Park, Jiangling Road 88, Binjiang District, Hangzhou, Zhejiang, China (310051)

Email: overseasbusiness@uniview.com; globalsupport@uniview.com

<http://www.uniview.com>

©2016-2018 Zhejiang Uniview Technologies Co., Ltd. All rights reserved.

*Product specifications and availability are subject to change without notice.